







Montageanleitung

Garderobenständer, Kleiderständer H4H322

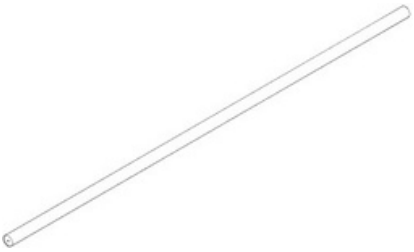
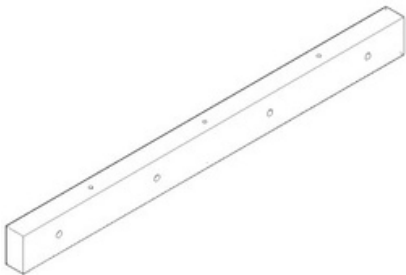
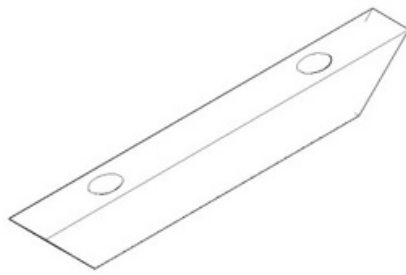
<p>A*1</p> 	<p>B*1</p> 	<p>C*5</p> 
<p>D*1</p> 	<p>E*2</p> 	<p>F*2</p> 
<p>G*6</p> 	<p>H*2</p> 	<p>I*28</p>  <p>M4*40</p>
<p>J*4</p>  <p>M4*30</p>		

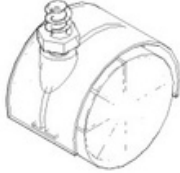
Montageanleitung

Garderobenständer, Kleiderständer H4H322

1

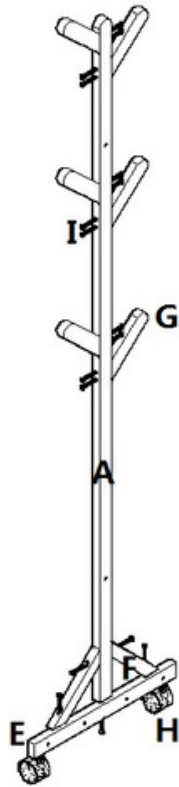

2

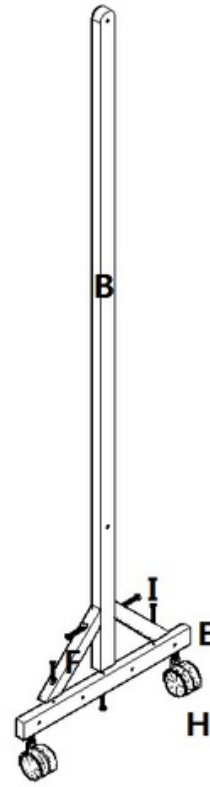

3

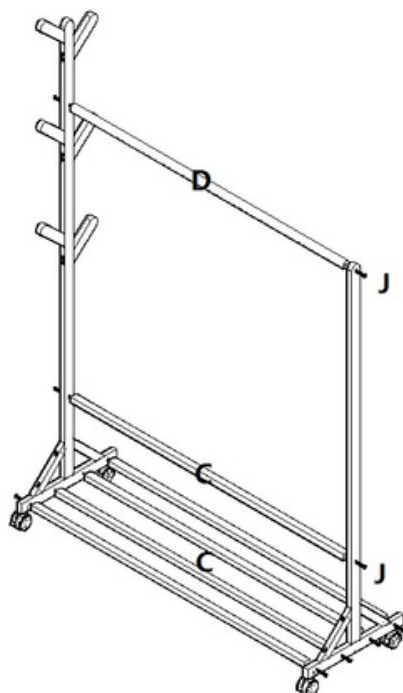



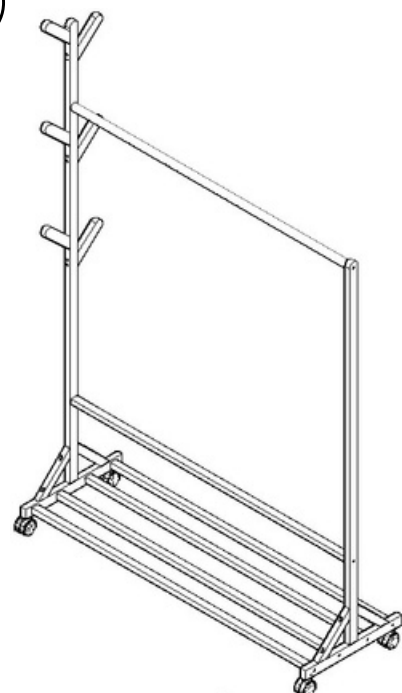

4

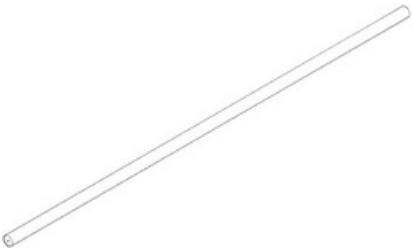
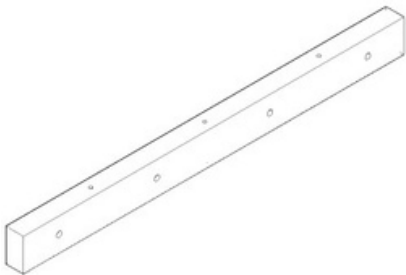
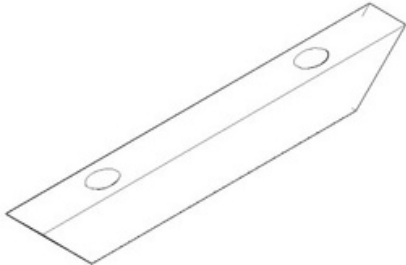
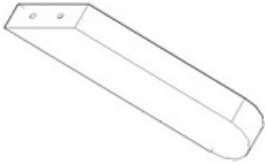
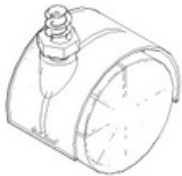

Assembly Instruction

Coat stand, Clothes rack H4H322

<p>A*1</p> 	<p>B*1</p> 	<p>C*5</p> 
<p>D*1</p> 	<p>E*2</p> 	<p>F*2</p> 
<p>G*6</p> 	<p>H*2</p> 	<p>I*28</p>  <p>M4*40</p>
<p>J*4</p>  <p>M4*30</p>		

Assembly Instruction

Coat stand, Clothes rack H4H322

1

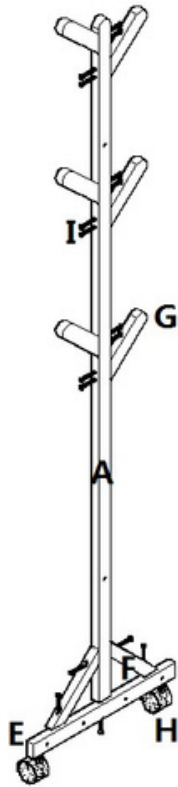

2

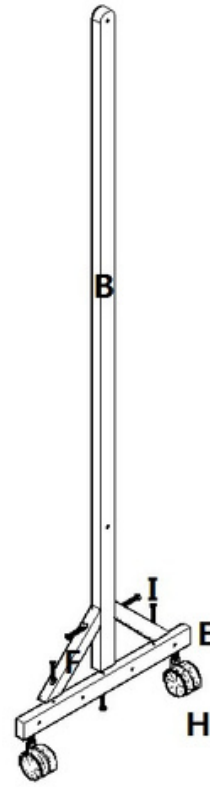

3

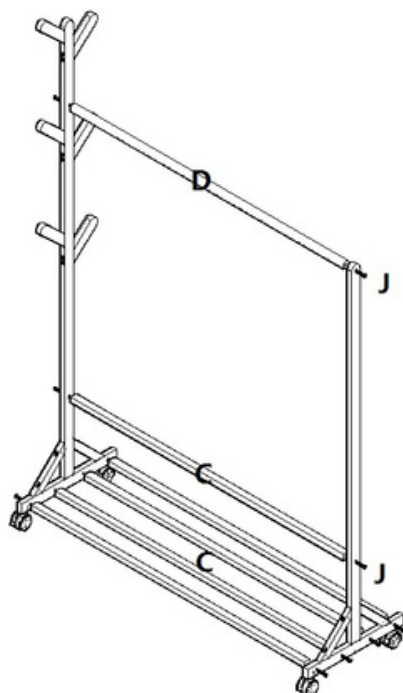

4

